

QuSpot for Teltonika RUTX50

PN: AX50S

**INTEGRATED MULTI-BAND LTE & 5G OMNI ANTENNA + WI-FI OMNI ANTENNA + GPS
+ PLACE TO INSTALL TELTONIKA RUTX50 (ALL-IN-ONE)**

QuSpot for RUTX50 is an outdoor antenna designed to provide reliable wireless connectivity in a variety of environments. This product is an all-in-one solution that integrates a high-gain, omnidirectional 5G and Wi-Fi antennas with RUTX50 into a single IP67 enclosure. Such integration allows implementation of new, outdoor RUTX50 solutions.

QuSpot for RUTX50 is an ideal solution for outdoor wireless connectivity in moving applications such as transportation, yachting, boats and camping but also city centres with high signal density.



OUTDOOR

Use Teltonika router
wherever you want

ANTENNA

Maximize your signal with
QuWireless antennas

SOLUTION

Plug Teltonika router and
you are good to go

LTE & 5G SPECIFICATION

FREQUENCY	0.617 - 0.960 GHz 1.7 - 2.7 GHz 3.3 - 4.3 GHz
GAIN	0.617 - 0.960 GHz: 2.5 dBi 1.7 - 2.7 GHz: 4 dBi 3.3 - 4.3 GHz: 4.5 dBi
Supported LTE/5G bands	1, 2, 3, 4, 5, 7, 8, 9, 10, 12, 13, 14, 17, 18, 19, 20, 22, 25, 26, 27, 28, 29, 30, 33, 34, 35, 36, 37, 38, 39, 40, 41, 42, 43, 44, 48, 49, 52, 53, 65, 66, 67, 68, 69, 71, 85, 103, n77, n78, n80, n81, n82, n83, n84, n86, n89, n90, n95, n97, n98, n100, n101
VSWR	<2.00, max <2.50
BEAMWIDTH	360°/35° ±5°
POLARIZATION	Vertical
IMPEDANCE	50 Ω

WI-FI SPECIFICATION

FREQUENCY	2.40 - 2.50 GHz 5.0 - 7.125 GHz
GAIN	2.40 - 2.50 GHz: 6 dBi 5.0 - 7.125 GHz: 7.5 dBi
VSWR	<1.70, max <2.00
BEAMWIDTH	360°/25° +/- 5°
POLARIZATION	Vertical
IMPEDANCE	50 Ω

MECHANICAL SPECIFICATION

MATERIALS	ABS, aluminum, PTFE, Fiberglass
INGRESS PROTECTION	IP67
CONNECTOR TYPE	RJ45
DIMENSIONS	240 x 160 x 160 mm 6.3 x 6.3 x 9.45 inch
WEIGHT	1.5 kg 3.31 lbs
OPERATING TEMPERATURE	From -40°C to 75°C From -40°F to 167°F

VSWR for LTE & 5G antenna

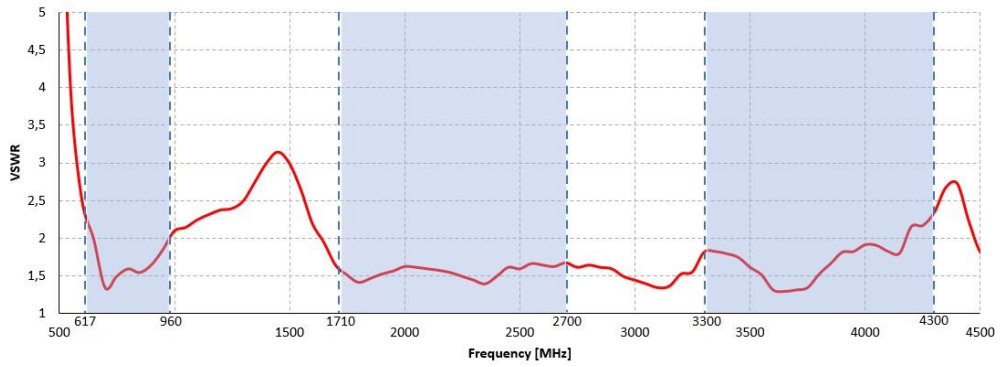

VSWR for Wi-Fi antenna

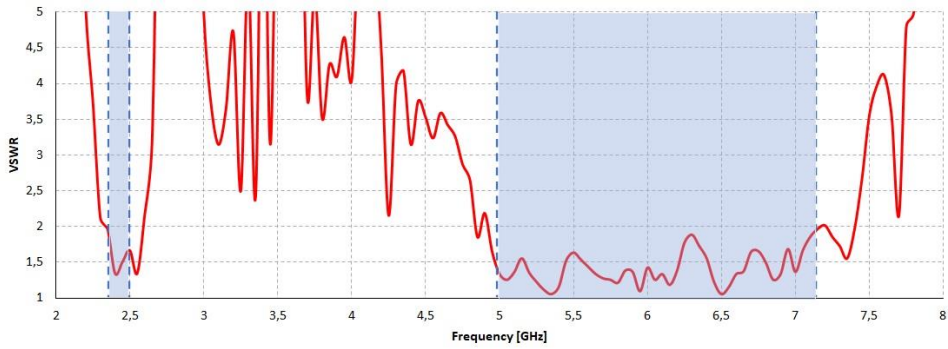

GAIN for LTE & 5G antenna

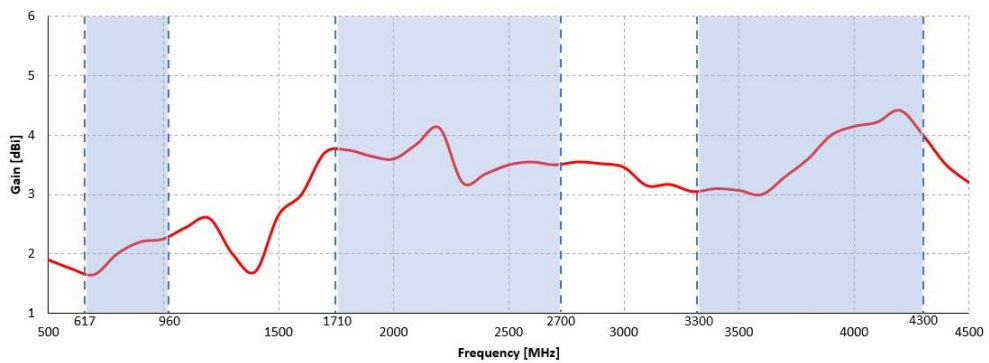

GAIN for Wi-Fi antenna

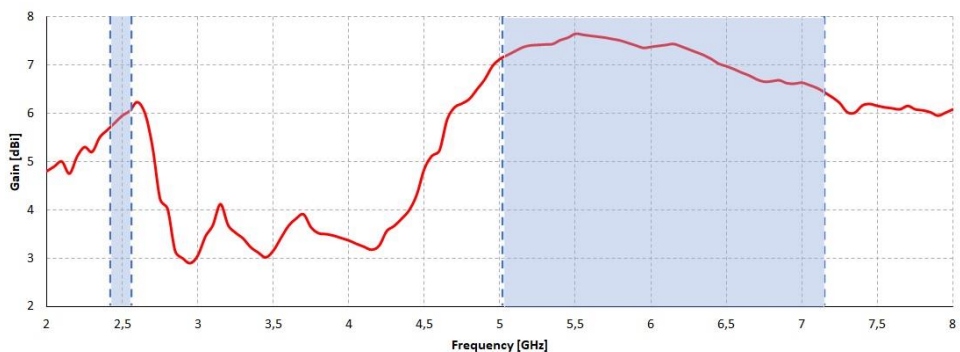

617-960 MHz Elevation

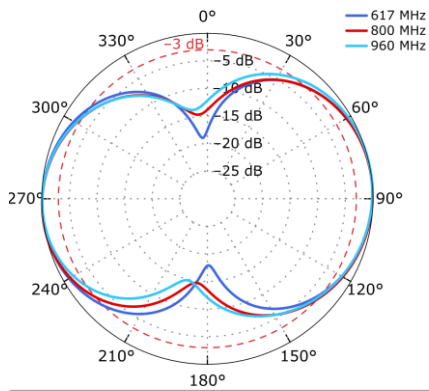

617-960 MHz Azimuth

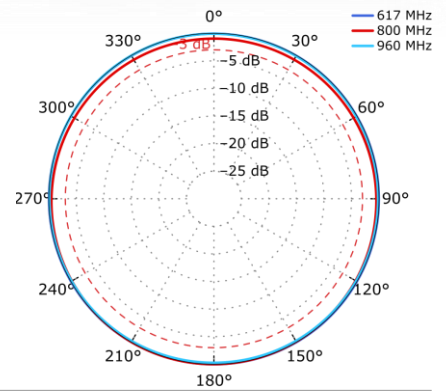

1710-2500 MHz Elevation

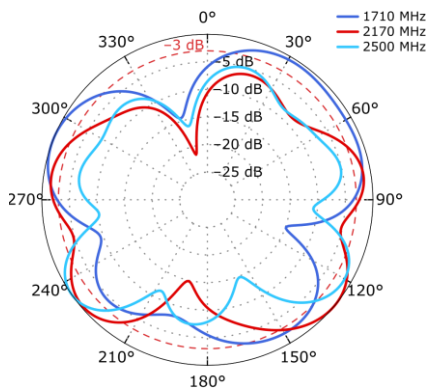

1710-2500 MHz Azimuth

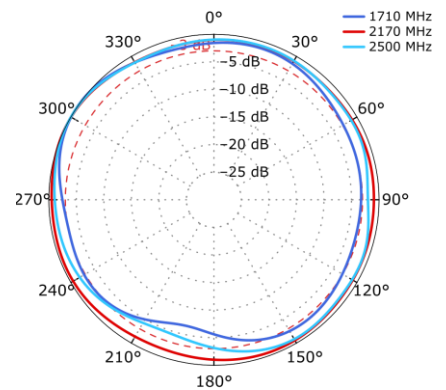

3300-4200 MHz Elevation

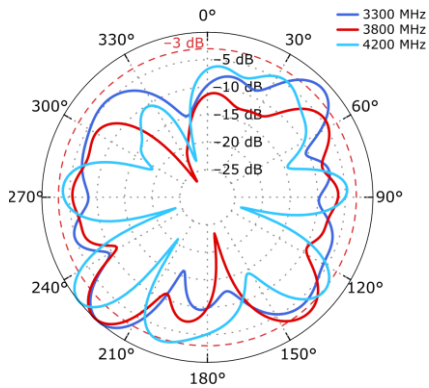

3300-4200 MHz Azimuth

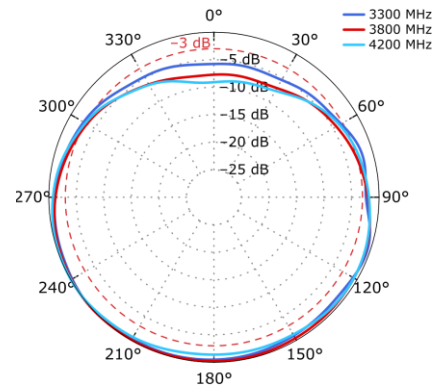

Wi-Fi Elevation

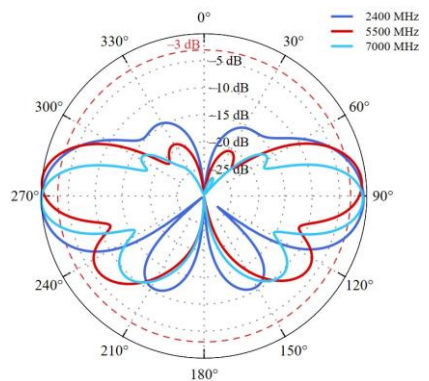

Wi-Fi Azimuth

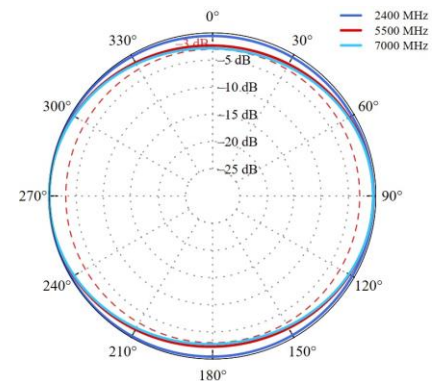

DEDICATED DEVICE SPECIFICATION

DIMENSIONS

Teltonika RUTX50



- RUTX50 is your future-proof, multi-network industrial router, offering 5G mobile communication for high-speed and data-heavy applications.
- 5G dual SIM cellular communication combined with 5 Gigabit Ethernet ports and dual-band Wi-Fi enables reliable ultra-low latency data transfer.
- The power of 5G technology, combined with a wide range of interfaces and industrial hardware features, ensures adaptability for future upgrades and expansions.
- RUTX50 comes with the RutOS, which provides advanced security features and specialized industrial protocols for a wide range of professional application scenarios, and is compatible with our Remote Management System (RMS), for optimized remote management and monitoring capabilities of large fleets of devices.

[Teltonika RUTX50 Datasheet](#)

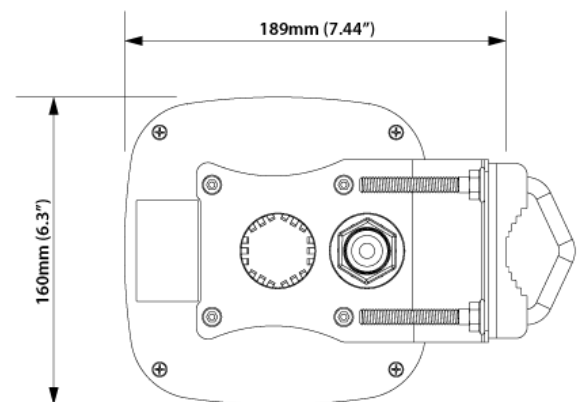
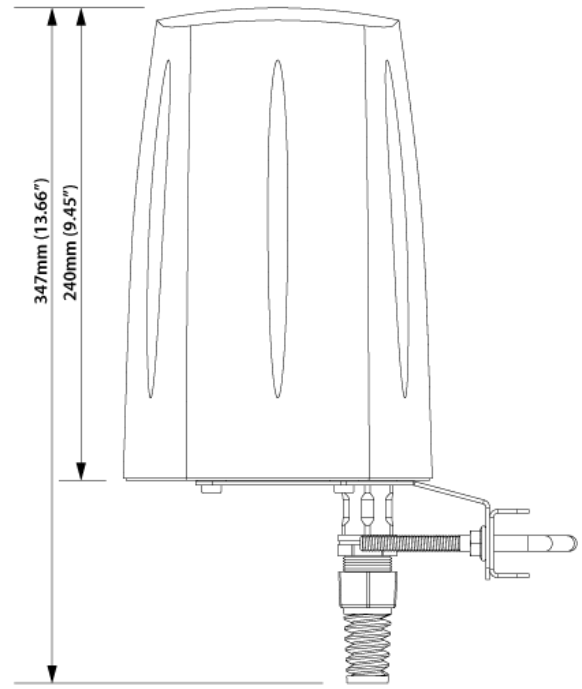

HEADQUARTER:

Wireless Instruments sp. z o.o.
ul. Kościuszki 27
52-116 Iwiny
POLAND

sales@quwireless.com
tel 1. +48 601 366 369
tel 2. +48 577 667 761
www.quwireless.com