

GNSS+NR MIMO×4+V2X MIMO Antenna JCE605NR4WM

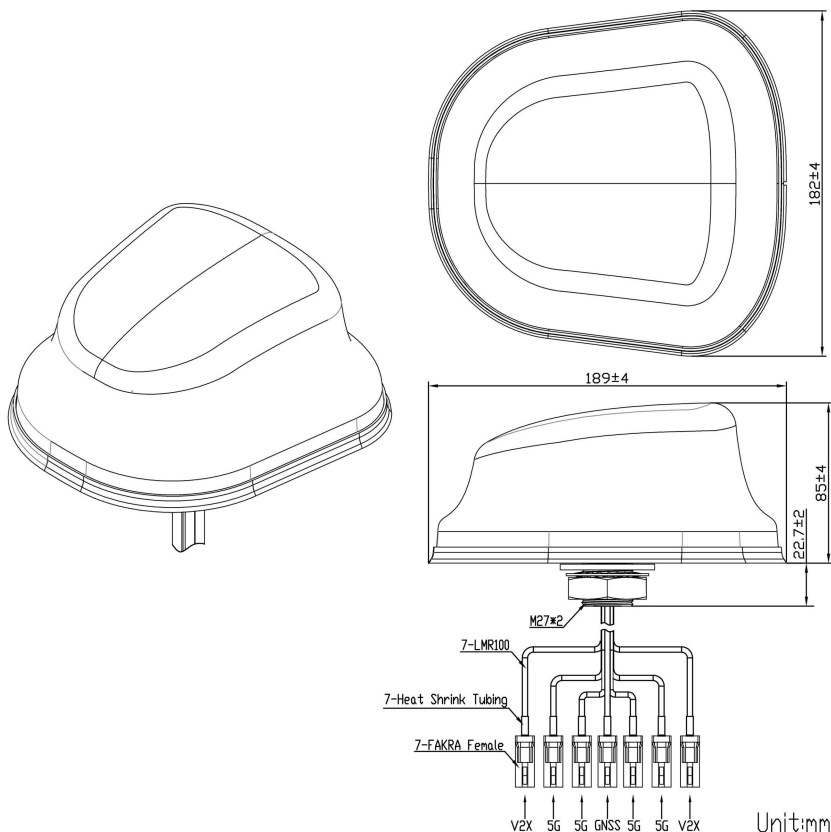

DIMENSIONS



JIAXING JINCHANG ELECTRONIC TECHNOLOGY CO.,LTD

Add: 398#,Zhenye Road, South Street, Jiaxing, Zhejiang, China

Http:// www.jinchanggps.com

E-mail:jcgps@vip.163.com

Tel: 86-0573-83692157/83692605/83958637 Fax:86-0573-83958635

SPECIFICATIONS

Item	Specifications	
GNSS Antenna	Frequency	GPS L1/L2/L5 GLONASS G1/G2/G3 COMPASS B1/B2/B3 Galileo E1/L1/E2/E5a/E5b/E6
	Polarization	RHCP
	LNA Gain	40 ± 2dB
	Noise Figure	≤2.0dB
	Supply Voltage	3~12V DC
	Current Consumption	≤60mA
	V.S.W.R	<2.0
	Impedance	50 Ω
5G NR Antenna MIMO*4	Frequency Range	698~960MHz/1710~2690MHz/2900~3800MHz
	V.S.W.R	<3.0
	Polarization	Linear
	Gain	4dBi (Typ.)
	Impedance	50Ω
V2X Antenna MIMO*2	Frequency Range	5850~5950MHz
	V.S.W.R	<2.5
	Polarization	Linear
	Gain	4dBi (Max.)
	Impedance	50Ω
Mechanical	Cable	LMR100*7
	Connector	FAKRA or others
	Material	PC/ABS
	Mounting Method	Screw
Environmental	Operating Temperature	-40°C~+85°C
	Relative Humidity	Up to 95%
	Ingress Protection	IP67 (exclude cable outlet)

	Vibration	10 to 55Hz with 1.5mm amplitude 2hours
	Environmentally Friendly	ROHS Compliant

Radiation Pattern

GNSS Antenna

XY-PLANE

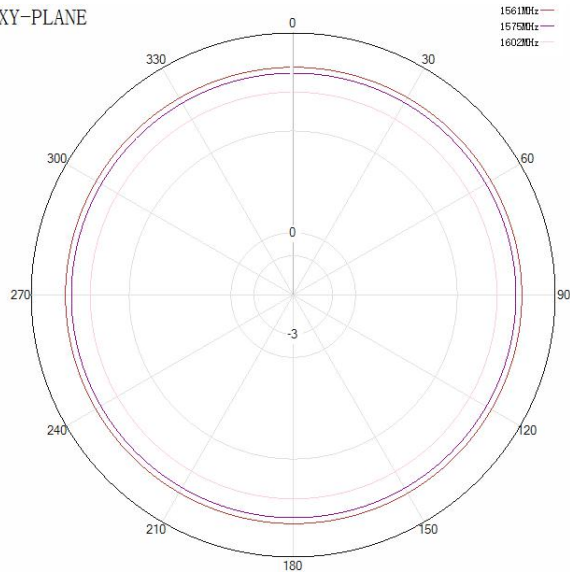

XZ-PLANE

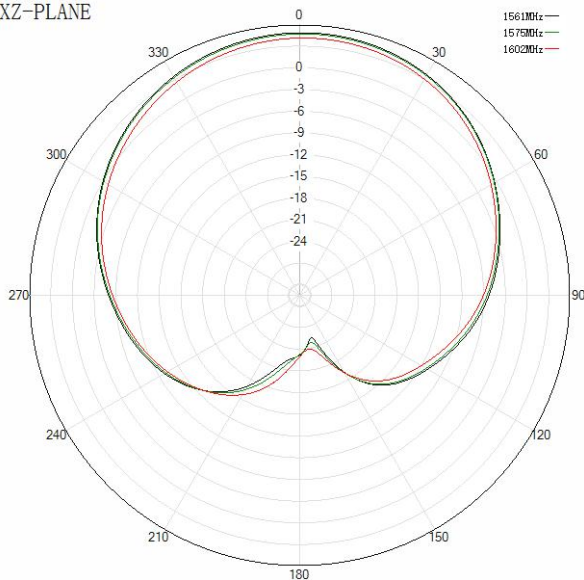

YZ-PLANE

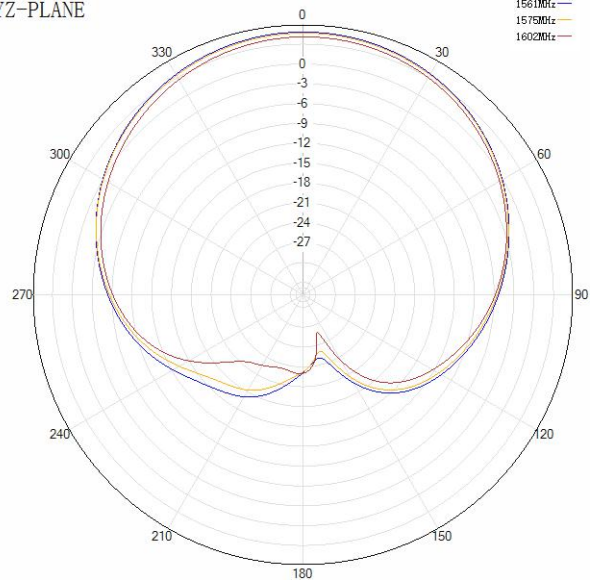



Jinchang Electron Global Service

XY-PLANE

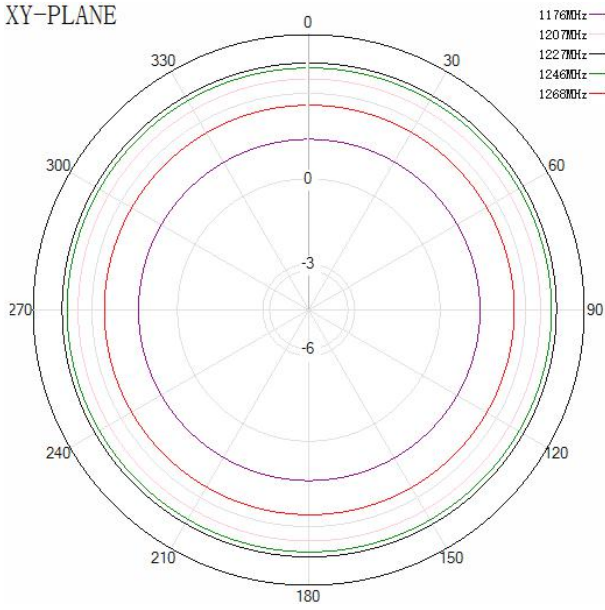

XZ-PLANE

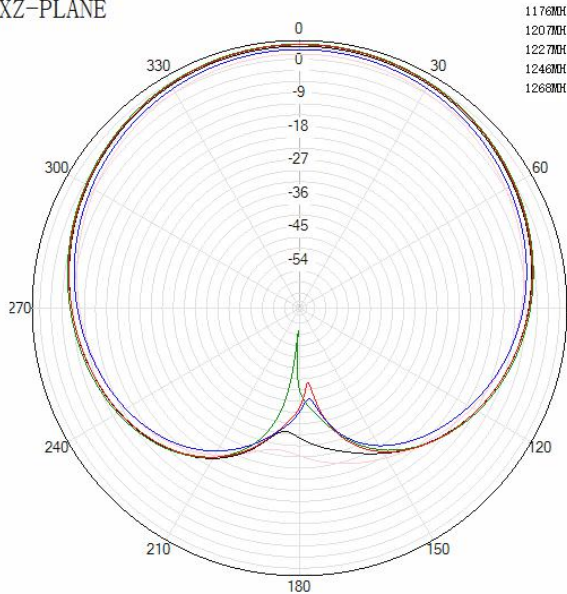

YZ-PLANE

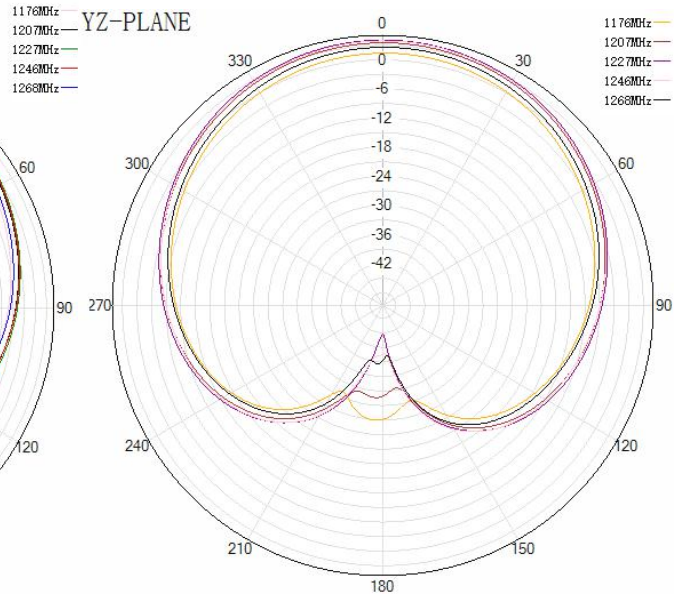

JIAXING JINCHANG ELECTRONIC TECHNOLOGY CO.,LTD

Add: 398#,Zhenye Road, South Street, Jiaxing, Zhejiang, China

Http:// www.jinchanggps.com

E-mail:jcgps@vip.163.com

Tel: 86-0573-83692157/83692605/83958637 Fax:86-0573-83958635

NR Antenna

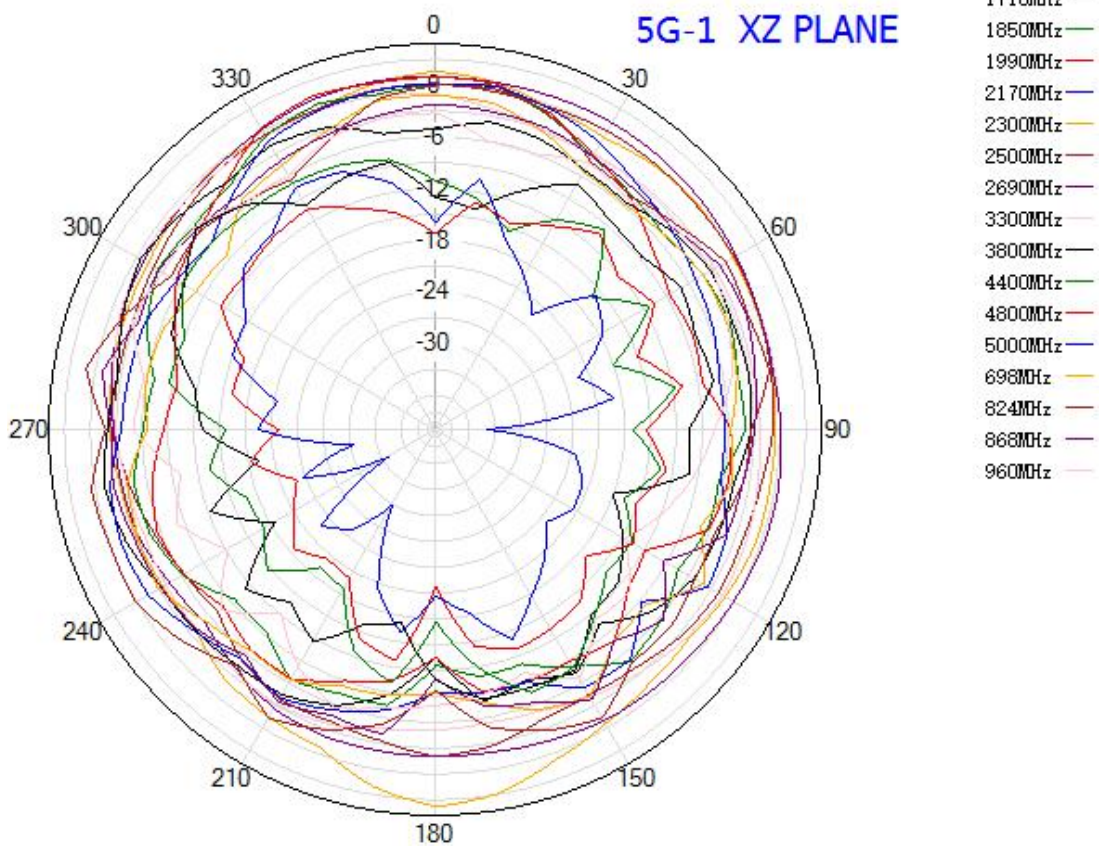
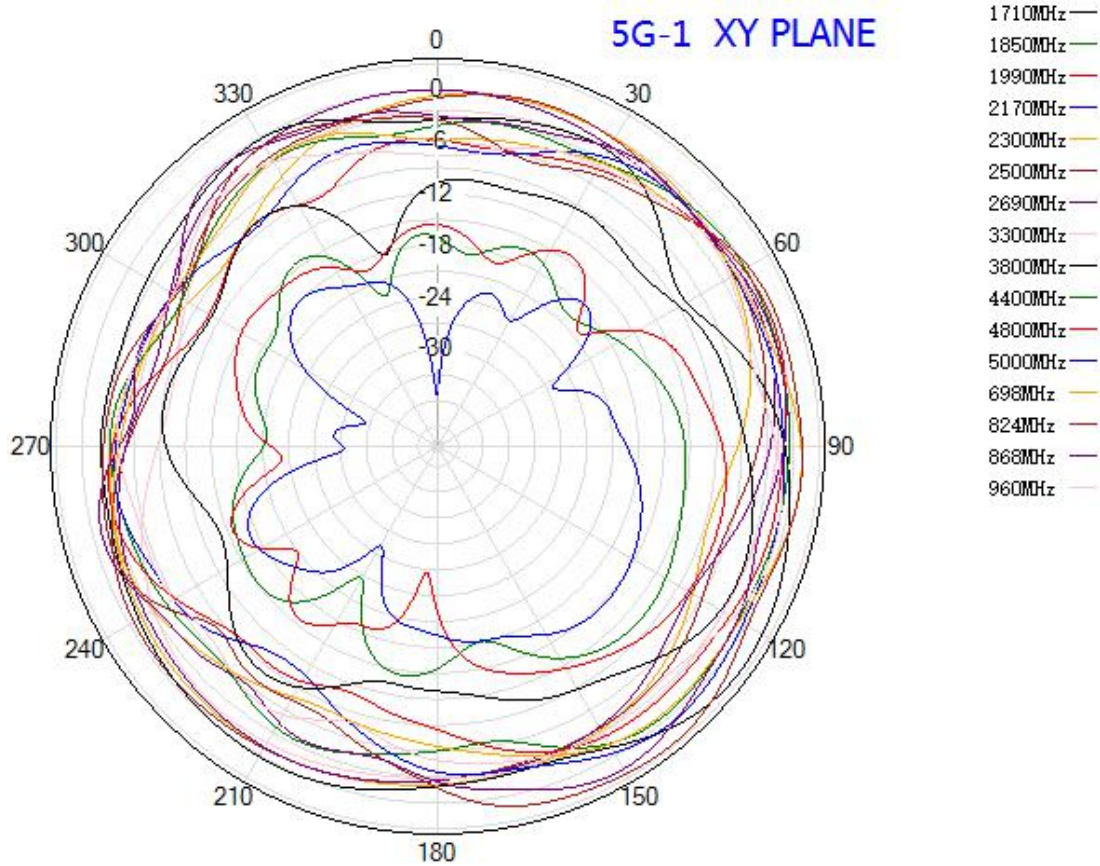

5G-1 YZ PLANE

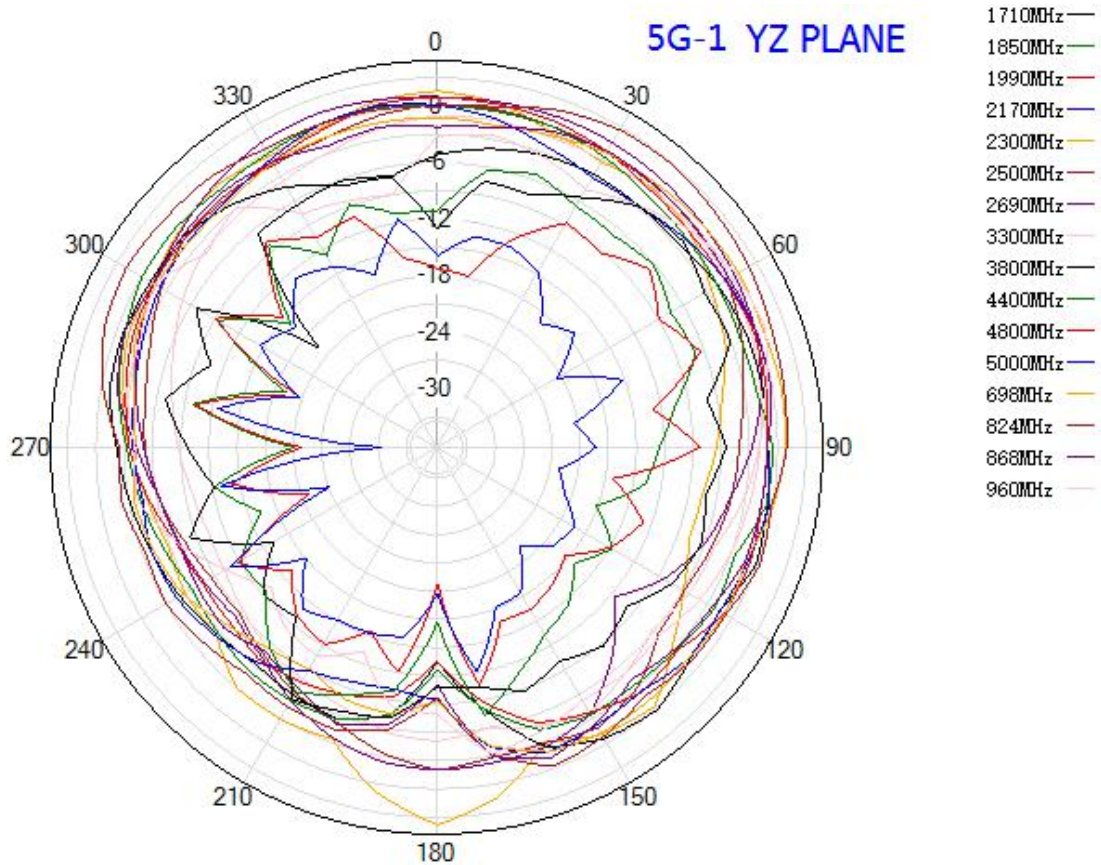

5G-2 XY PLANE

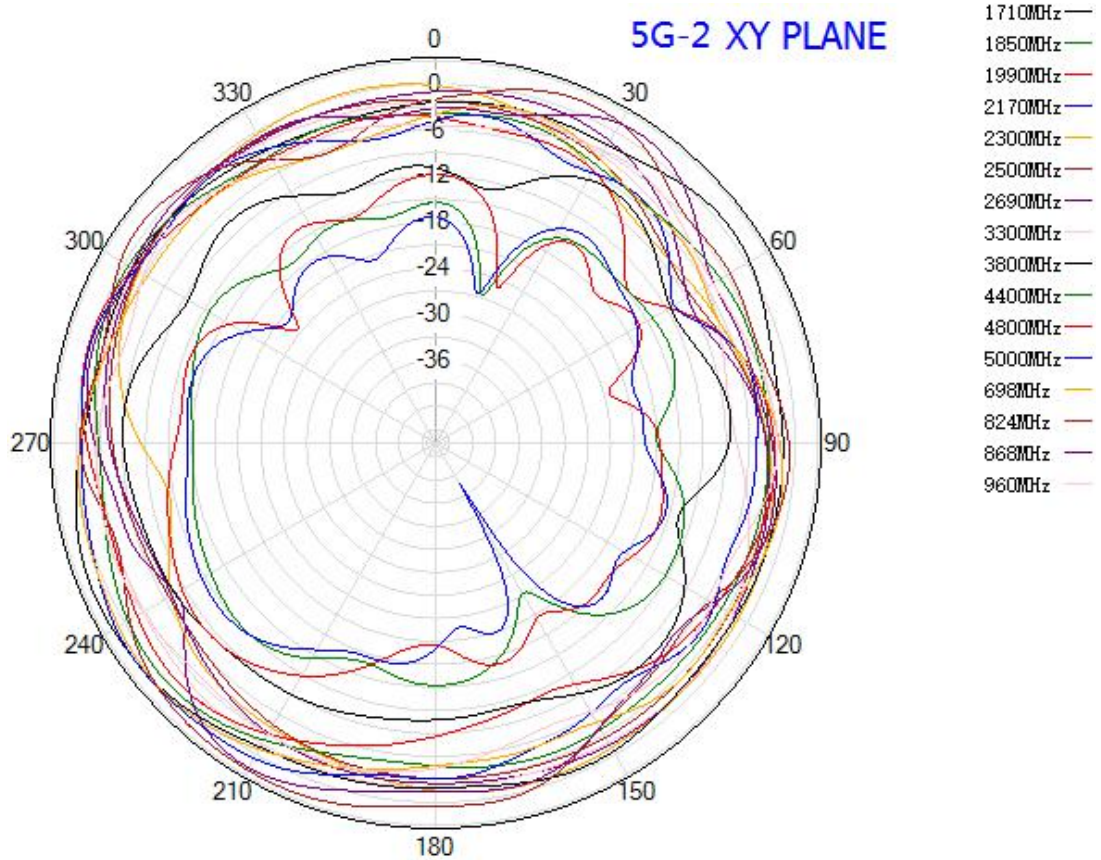

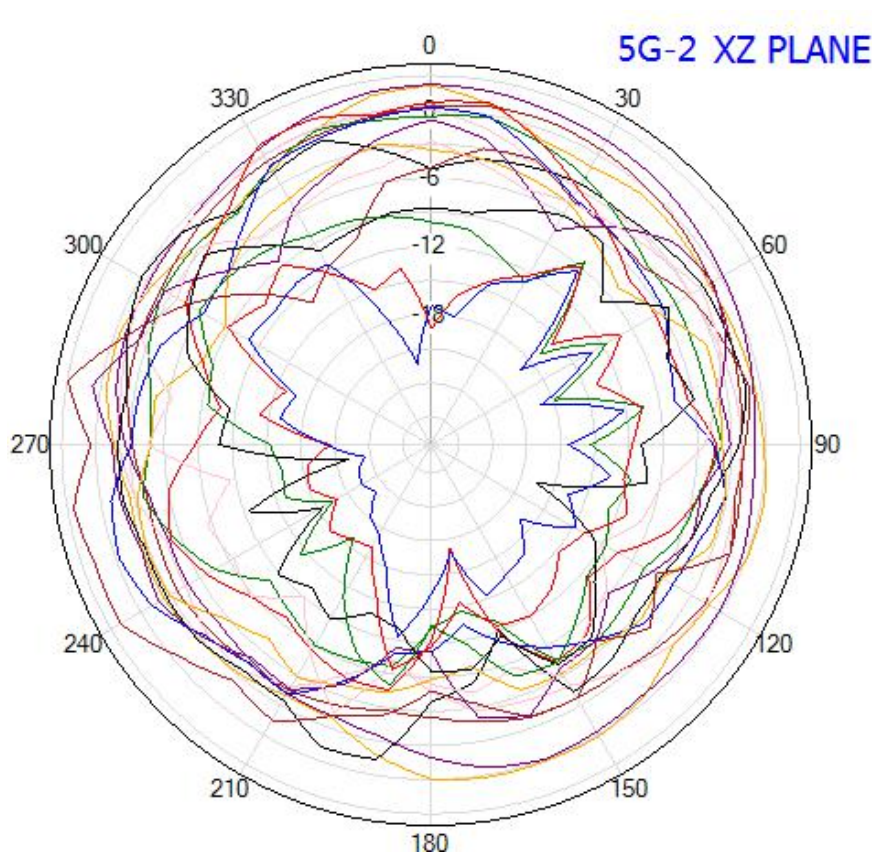

- 1710MHz —
- 1850MHz —
- 1990MHz —
- 2170MHz —
- 2300MHz —
- 2500MHz —
- 2690MHz —
- 3300MHz —
- 3800MHz —
- 4400MHz —
- 4800MHz —
- 5000MHz —
- 698MHz —
- 824MHz —
- 868MHz —
- 960MHz —

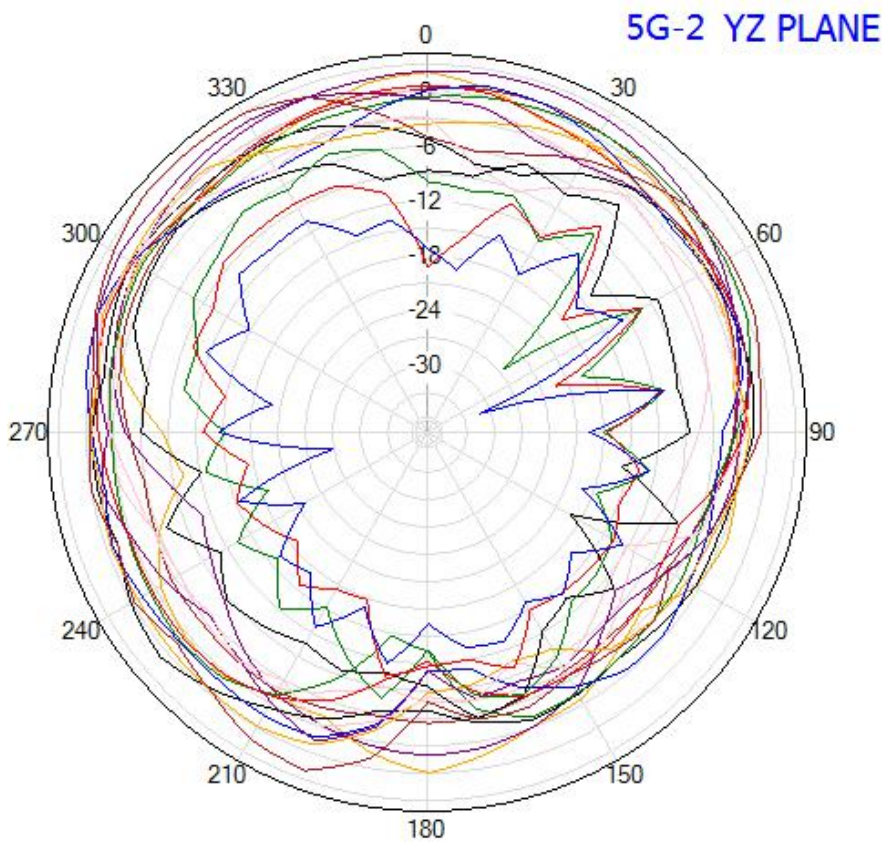

- 1710MHz —
- 1850MHz —
- 1990MHz —
- 2170MHz —
- 2300MHz —
- 2500MHz —
- 2690MHz —
- 3300MHz —
- 3800MHz —
- 4400MHz —
- 4800MHz —
- 5000MHz —
- 698MHz —
- 824MHz —
- 868MHz —
- 960MHz —

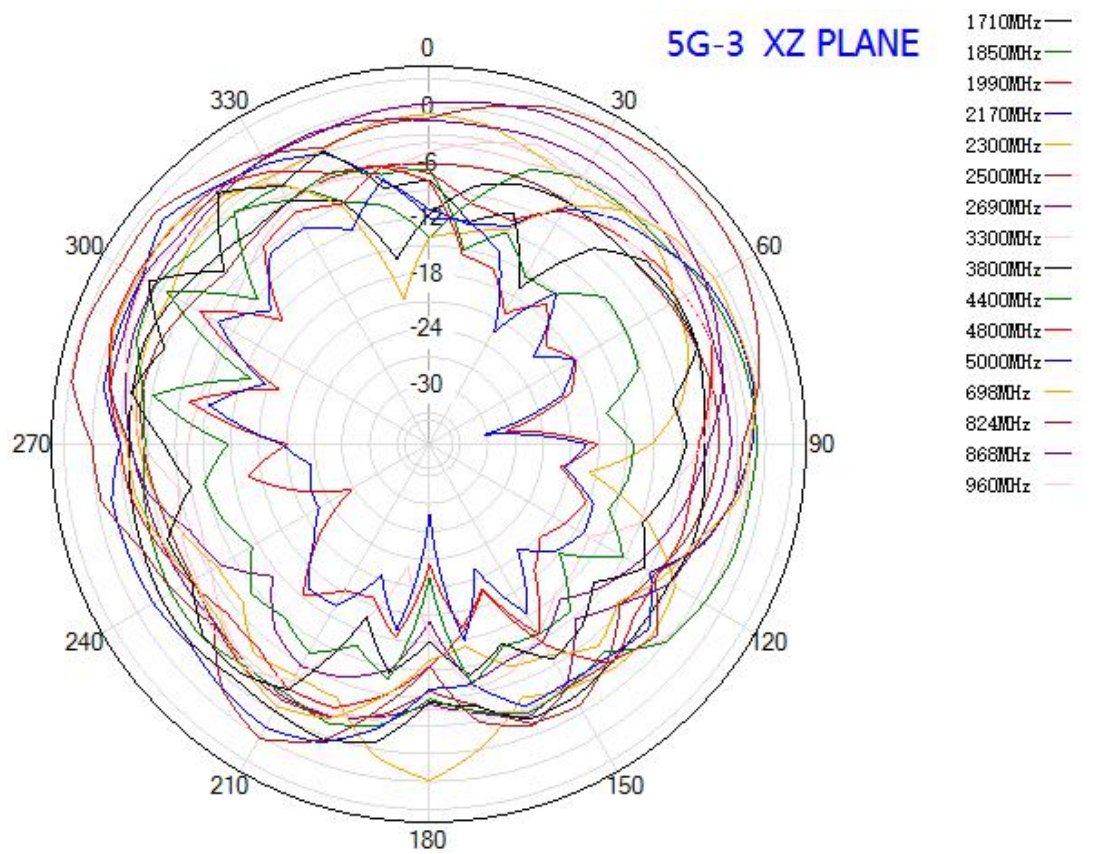
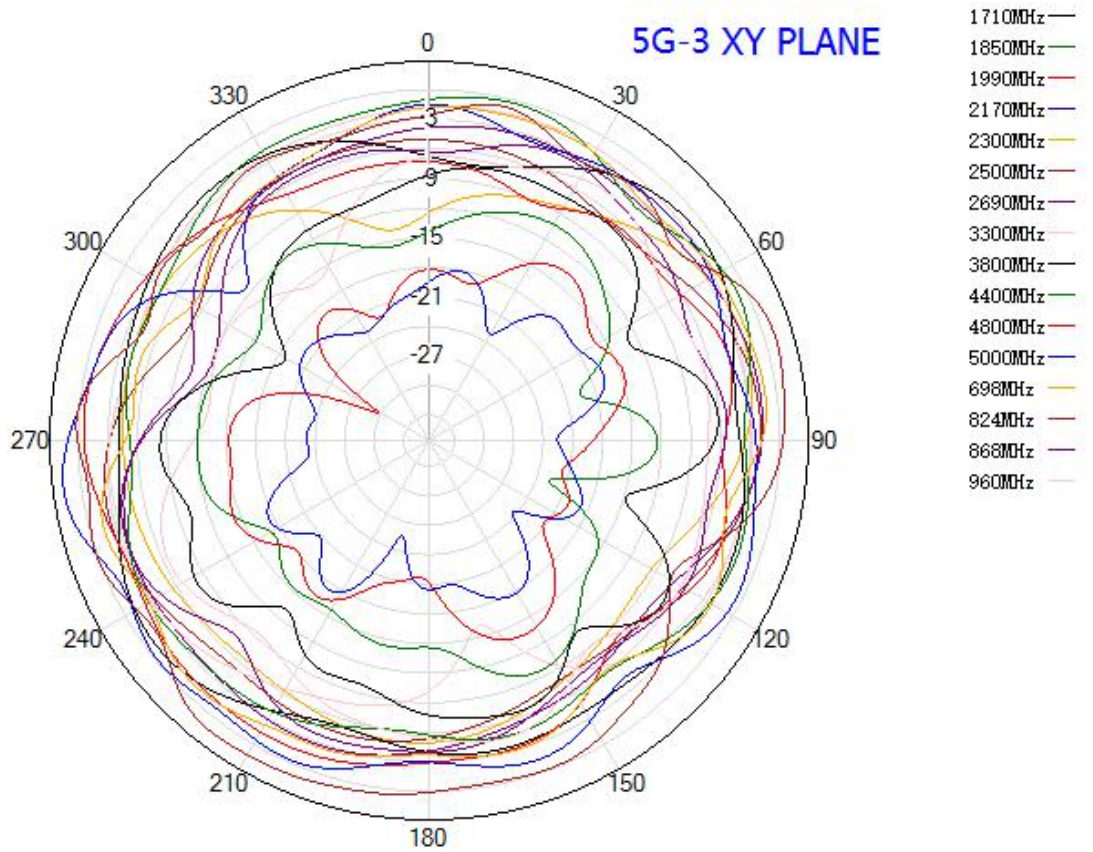

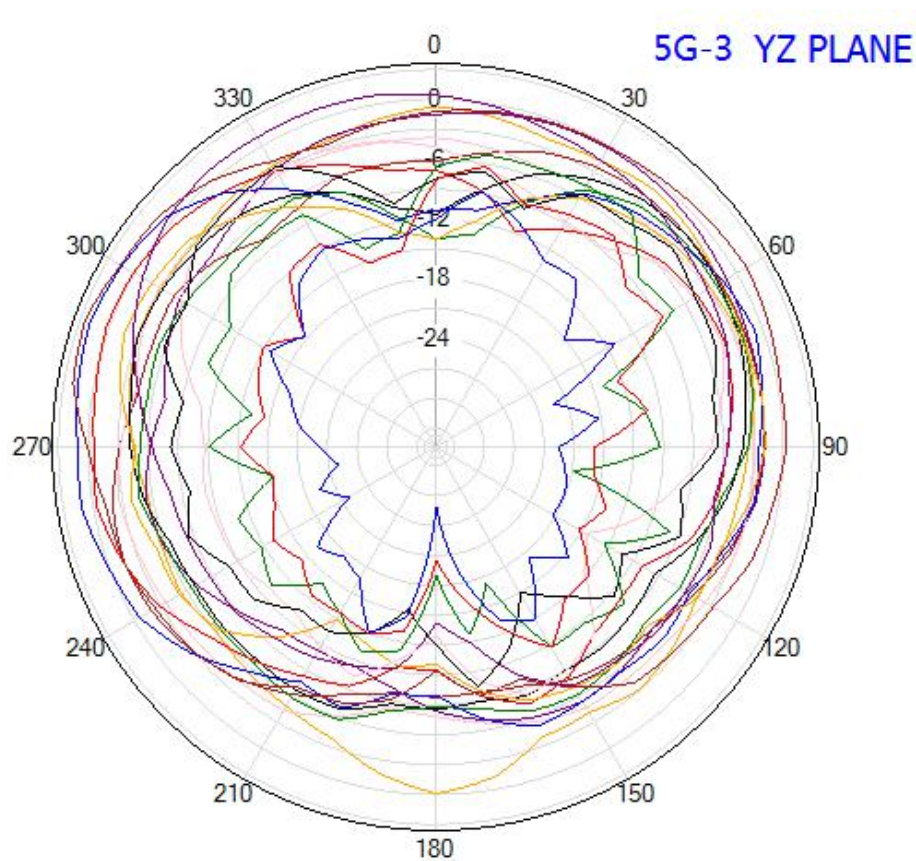

- 1710MHz
- 1850MHz
- 1990MHz
- 2170MHz
- 2300MHz
- 2500MHz
- 2690MHz
- 3300MHz
- 3800MHz
- 4400MHz
- 4800MHz
- 5000MHz
- 698MHz
- 824MHz
- 868MHz
- 960MHz

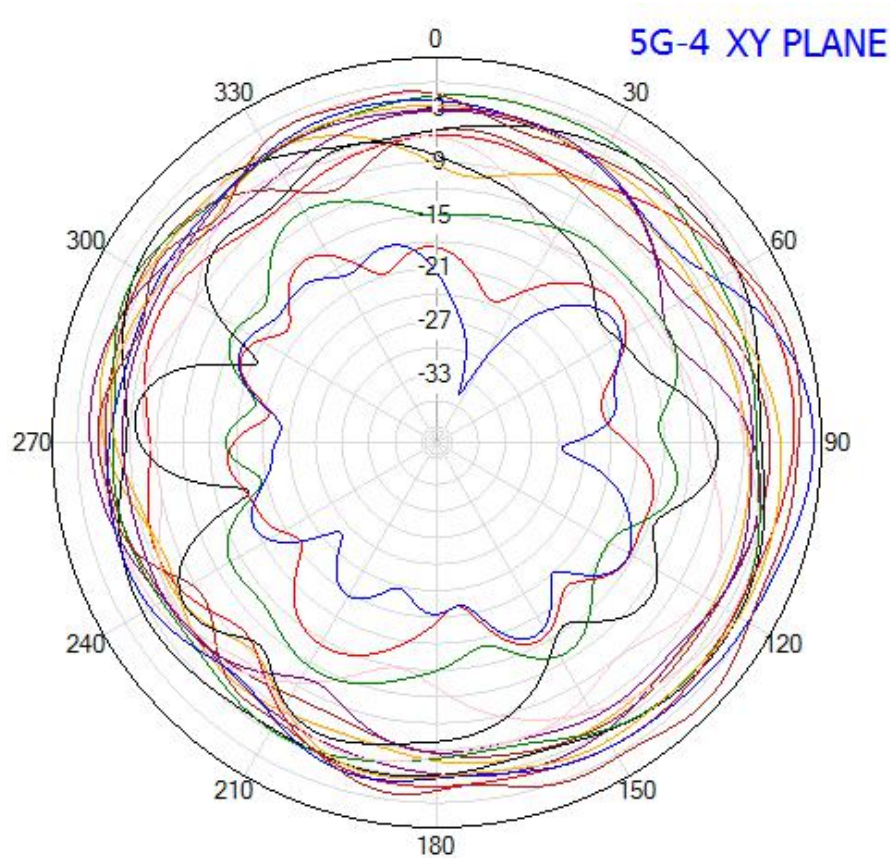

- 1710MHz
- 1850MHz
- 1990MHz
- 2170MHz
- 2300MHz
- 2500MHz
- 2690MHz
- 3300MHz
- 3800MHz
- 4400MHz
- 4800MHz
- 5000MHz
- 698MHz
- 824MHz
- 868MHz
- 960MHz

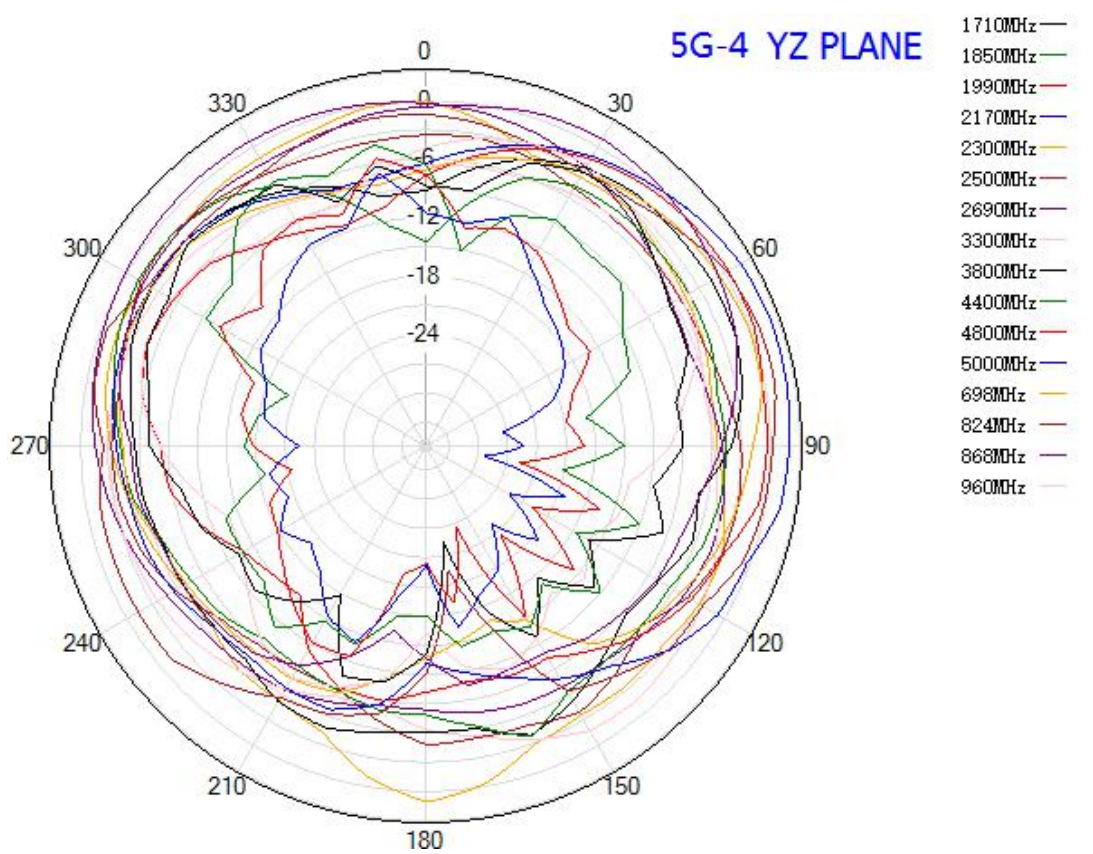
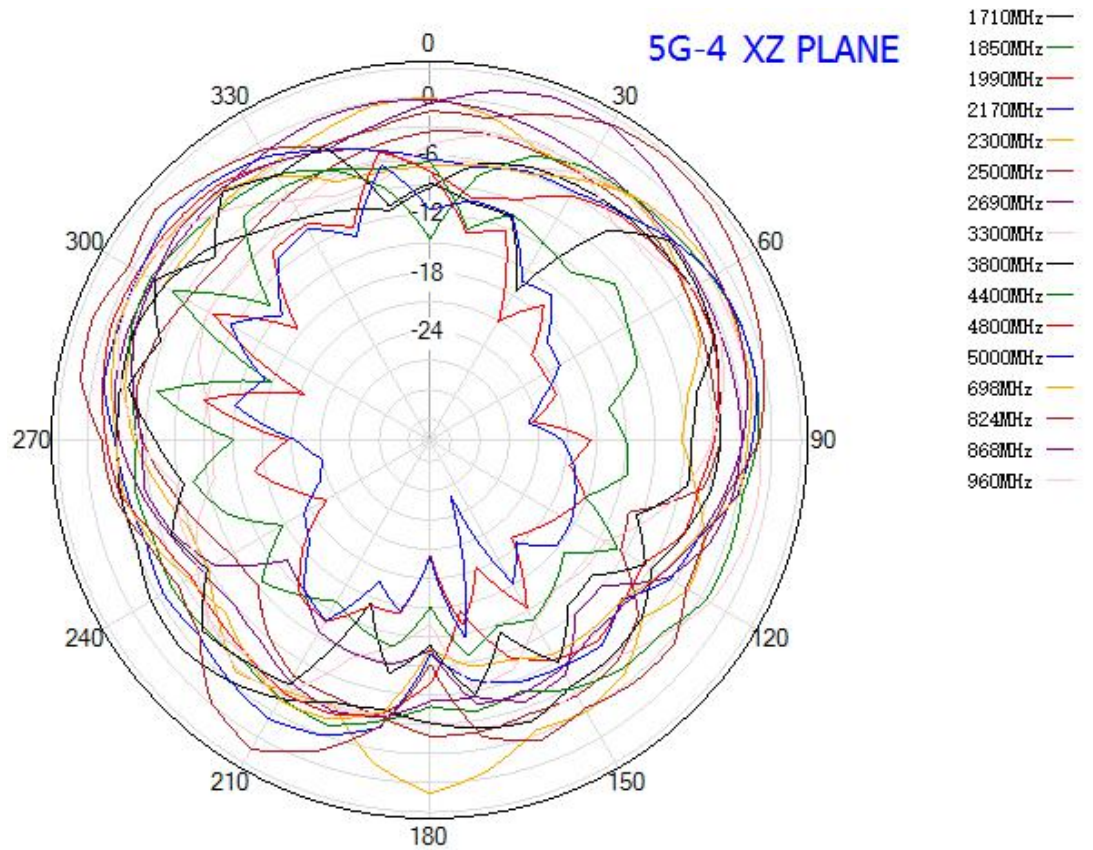

V2X Antenna

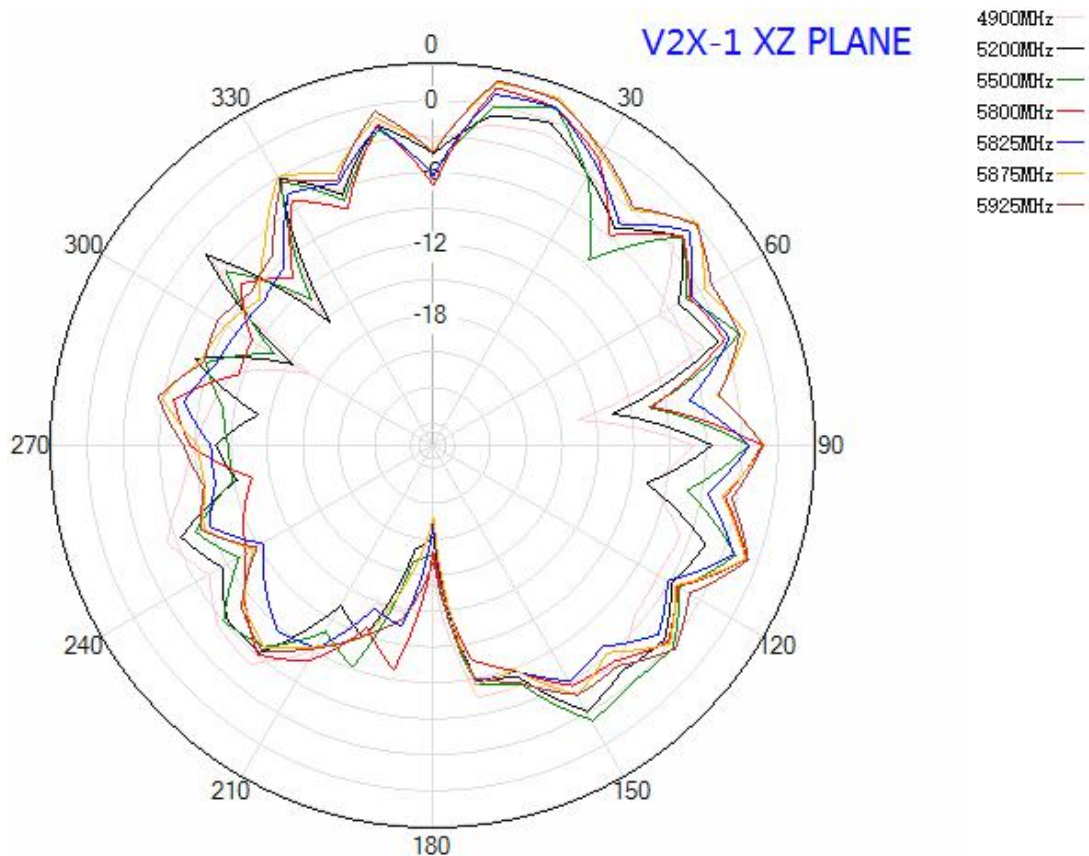
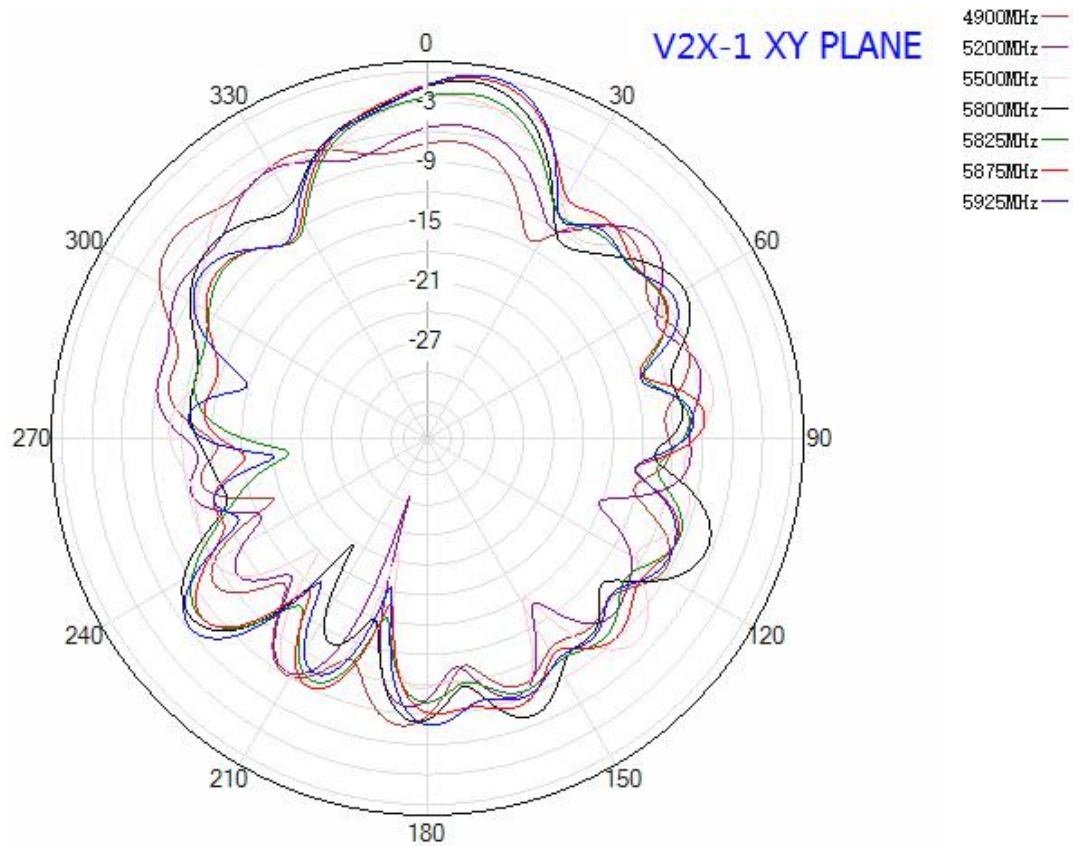

JIAXING JINCHANG ELECTRONIC TECHNOLOGY CO.,LTD

Add: 398#,Zhenye Road, South Street, Jiaxing, Zhejiang, China

Http:// www.jinchanggps.com

E-mail:jcgps@vip.163.com

Tel: 86-0573-83692157/83692605/83958637 Fax:86-0573-83958635

