

 **TELTONIKA**  
**FMC130**

Advanced LTE terminal with  
flexible inputs configuration

**Quick Manual**  
**v1.5**

# Table of Contents

|  |           |
|--|-----------|
| <b>Know your device</b> .....                              | <b>3</b>  |
| Pinout .....   | 4         |
| Wiring scheme .....  | 5         |
| <b>Set up your device</b> .....                            | <b>6</b>  |
| How to insert Micro-SIM card and connect the battery ..... | 6         |
| PC Connection (Windows) .....                              | 7         |
| How to install USB drivers (Windows) .....                 | 7         |
| Configuration (Windows) .....                              | 7         |
| Quick SMS configuration.....                               | 8         |
| <b>Mounting recommendations</b> .....                      | <b>10</b> |
| <b>LED indications</b> .....                               | <b>11</b> |
| <b>Characteristics</b> .....                               | <b>11</b> |
| Basic characteristics.....                                 | 11        |
| Electrical characteristics .....                           | 12        |
| <b>Safety information</b> .....                            | <b>14</b> |
| <b>Certification and Approvals</b> .....                   | <b>15</b> |

|                          |           |
|--------------------------|-----------|
| <b>Warranty</b> .....    | <b>16</b> |
| Warranty Disclaimer..... | 16        |

# Know your device

Top view

2x6 socket

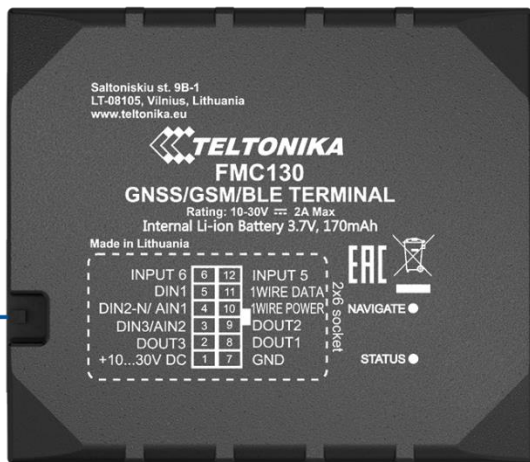

Bottom view  
(without cover)

Micro-USB Micro SIM slot

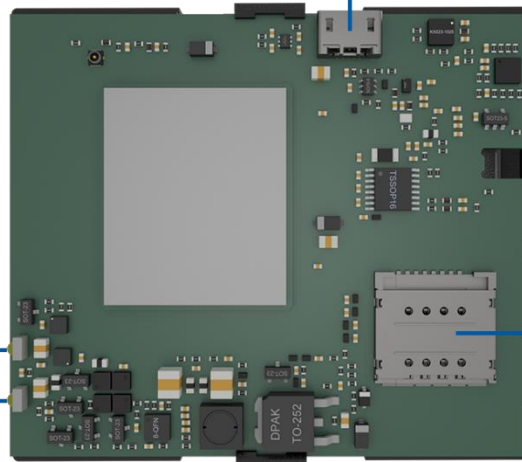

Navigate LED

Status LED

Top view  
(without cover)

Battery socket

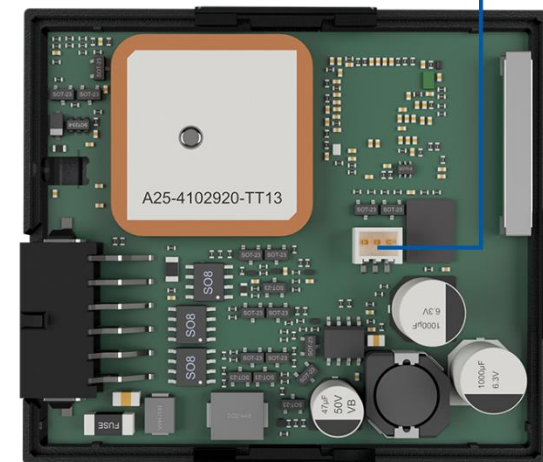

Figure 1 FMC130 device view

# Pinout

**Table 1 FMC130 2x6 socket pinout**

| PIN NUMBER | PIN NAME             | DESCRIPTION  |
|------------|----------------------|--|
| 1          | VCC (10-30) V DC (+) | Power supply (10-30 V DC).   |
| 2          | DOUT 3               | Digital output, channel 3. Open collector output. Max. 0,5 A DC.   |
| 3          | DIN 3 / AIN 2        | Analog input, channel 2. Input range: 0-30 V DC / Digital input, channel 3.                              |
| 4          | DIN 2-N / AIN 1      | Digital input, channel 2, Negative input (ground sense), Analog input, channel 1, Input range: 0-30 VDC. |
| 5          | DIN 1                | Digital input, channel 1.  |
| 6          | INPUT 6              | TX EXT (LV CAN – TX).  |
| 7          | GND (-)              | Ground pin. (10-30) V DC (—)   |
| 8          | DOUT 1               | Digital output, channel 1. Open collector output. Max. 0,5 A DC.   |
| 9          | DOUT 2               | Digital output, channel 2. Open collector output. Max. 0,5 A DC.   |
| 10         | 1WIRE POWER          | +3,8 V output for 1–Wire devices.  |
| 11         | 1WIRE DATA           | Data for 1–Wire devices.   |
| 12         | INPUT 5              | RX EXT (LV CAN - RX).  |



**Figure 2 FMC130 2x6 socket pinout**

# Wiring scheme

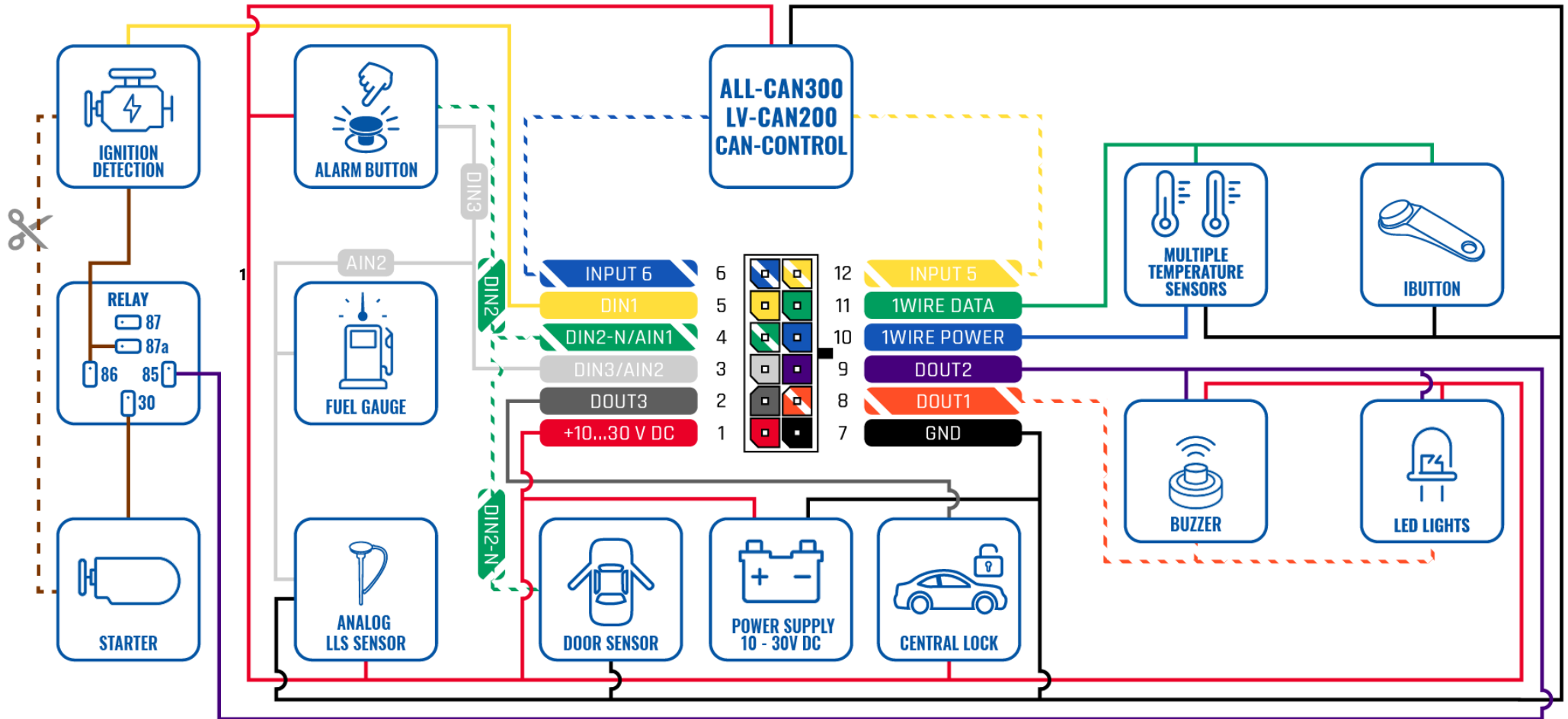

Figure 3 FMC130 Wiring scheme

<sup>1</sup> Automotive relay

# Set up your device

## How to insert Micro-SIM card and connect the battery

1. Gently remove FMC130 **bottom cover** using **plastic pry tool** from both sides. Then remove the **top cover**.
2. Insert **Micro-SIM** card as shown with **PIN request disabled** or read our [Wiki](#) how to enter it later in [Teltonika Configurator](#). Make sure that Micro-SIM card **cut-off corner** is pointing forward to slot.
3. Connect **battery** as shown to device. Position the battery in place where it does not obstruct other components.
4. After **configuration**, see "[PC Connection \(Windows\)](#)", attach device **top** and **bottom cover** back.

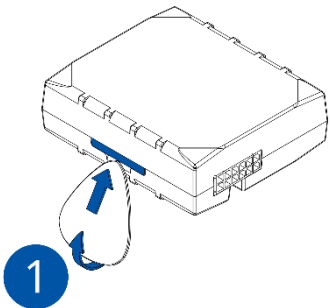

Figure 4 Covers removal

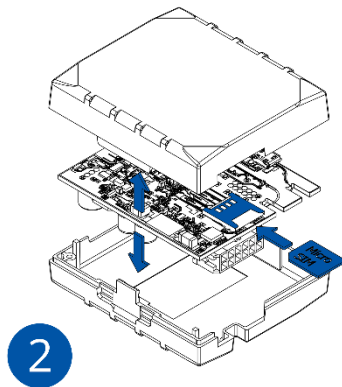

Figure 5 Micro-SIM card insert

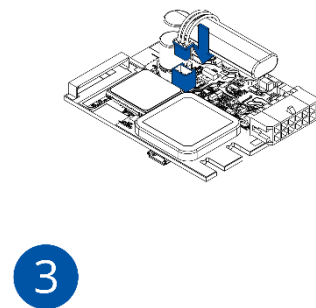

Figure 6 Battery connection

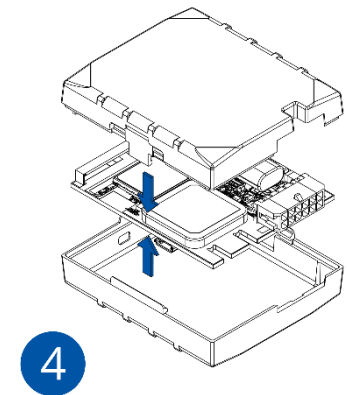

Figure 7 Cover removal

## PC Connection (Windows)

1. Power-up FMC130 with **DC voltage (10 – 30 V)** power supply using **supplied power cable**. LED's should start blinking, see "[LED indications](#)".
2. Connect device to computer using **Micro-USB cable** or **Bluetooth** connection:
  - Using **Micro-USB cable**
    - You will need to install USB drivers, see "[How to install USB drivers \(Windows\)](#)"
  - Using **Bluetooth**
    - FMC130 Bluetooth is enabled by default. Turn on **Bluetooth** on your PC, then select **Add Bluetooth or other device** > **Bluetooth**. Choose your device named – "**FMCxxx\_last\_7\_imei\_digits**", without **LE** in the end. Enter default password **5555**, press **Connect** and then select **Done**.
3. You are now ready to use the device on your computer.

## How to install USB drivers (Windows)

1. Please download COM port drivers from [here](#).
2. Extract and run **TeltonikaCOMDriver.exe**.
3. Click **Next** in driver installation window.
4. In the following window click **Install** button.

Setup will continue installing the driver and eventually the confirmation window will appear. Click **Finish** to complete the setup.

## Configuration (Windows)

At first FMC130 device will have default factory settings set. These settings should be changed according to the user's needs. Main configuration can be performed via [Teltonika Configurator](#) software. Get the latest **Configurator** version from [here](#). Configurator operates on **Microsoft Windows OS** and uses prerequisite **MS .NET Framework**. Make sure you have the correct version installed.

**Table 2 MS .NET requirements**

| MS .NET REQUIREMENTS                                    |                           |               |  |
|---|---------------------------|---------------|--|
| Operating system  | MS .NET Framework version | Version       | Links  |
| Windows Vista<br>Windows 7<br>Windows 8.1<br>Windows 10 | MS .NET Framework 4.6.2   | 32 and 64 bit | <a href="http://www.microsoft.com">www.microsoft.com</a> |

Downloaded **Configurator** will be in compressed archive. Extract it and launch **Configurator.exe**. After launch software language can be changed by clicking  in the right bottom corner ([Figure 8 Language selection](#)).

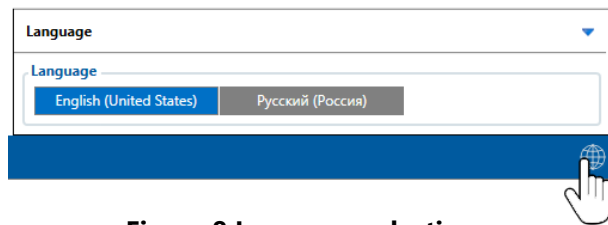

Figure 8 Language selection

Configuration process begins by pressing on connected device (Figure 9 Device connected via USB).



Figure 9 Device connected via USB

After connection to Configurator **Status window** will be displayed (Figure 10 Configurator Status window).

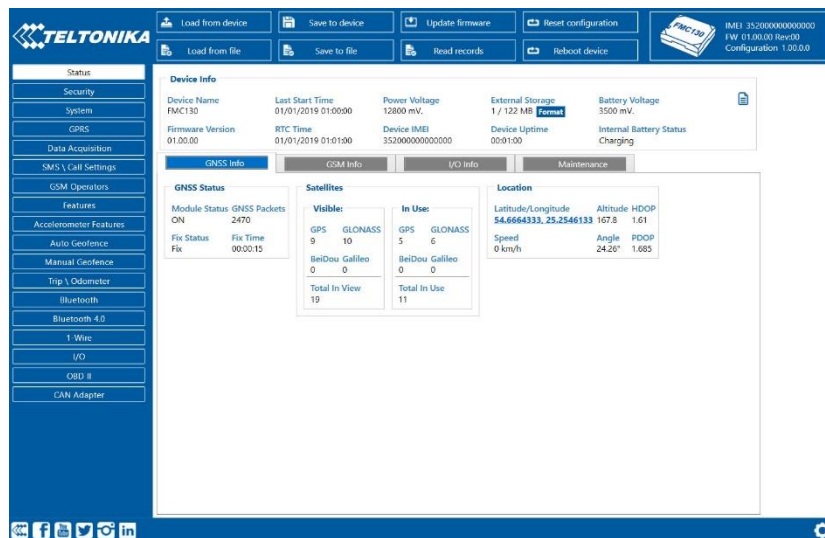

Figure 10 Configurator Status window

Various **Status window** tabs display information about **GNSS**, **GSM**, **I/O**, **Maintenance** and etc. FMC130 has one user editable profile, which can be loaded and saved to the device. After any modification of configuration the changes need to be saved to device using **Save to device** button. Main buttons offer following functionality:

1. **Load from device** – loads configuration from device.
2. **Save to device** – saves configuration to device.
3. **Load from file** – loads configuration from file.
4. **Save to file** – saves configuration to file.
5. **Update firmware** – updates firmware on device.
6. **Read records** – reads records from the device.
7. **Reboot device** – restarts device.
8. **Reset configuration** – sets device configuration to default.

Most important configurator section is **GPRS** – where all your server and **GPRS settings** can be configured and **Data Acquisition** – where data acquiring parameters can be configured.

More details about FMC130 configuration using Configurator can be found in our [Wiki](#).

## Quick SMS configuration



Default configuration has optimal parameters present to ensure best performance of track quality and data usage.

Quickly set up your device by sending this SMS command to it:

```
" setparam 2001:APN;2002:APN_username;2003:APN_password;2004:Domain;2005:Port;2006:0"
```

**Note:** Before SMS text, two space symbols should be inserted.

GPRS settings:

- 2001 – APN
- 2002 – APN username (if there are no APN username, empty field should be left)
- 2003 – APN password (if there are no APN password, empty field should be left)

Server settings:

- 2004 – Domain
- 2005 – Port
- 2006 – Data sending protocol (0 – TCP, 1 – UDP)

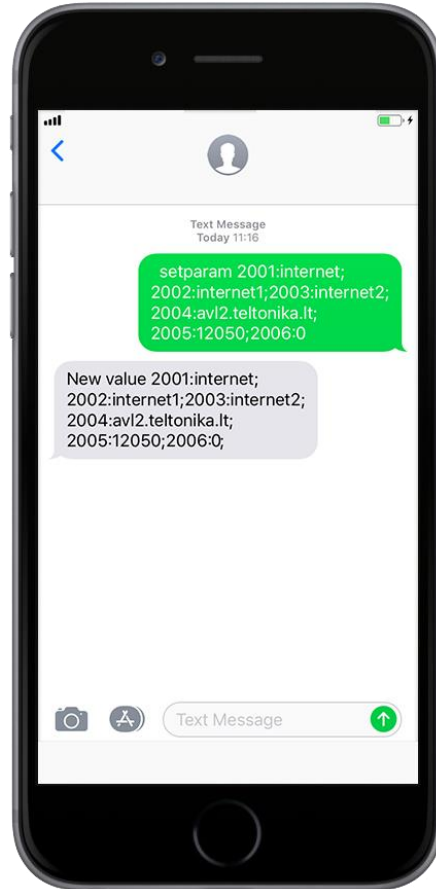

### Default configuration settings

Movement and ignition detection:



Vehicle movement will be detected by accelerometer



Ignition will be detected by vehicle power voltage between 13,2 – 30 V

Device makes a record **On Moving** if one of these events happen:



300 seconds passes



Vehicle turns 10 degrees



Vehicle drives 100 meters

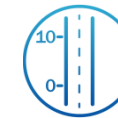

Speed difference between last coordinate and current position is greater than 10 km/h

Device makes a record **On Stop** if:



1 hour passes while vehicle is stationary and ignition is off

Records sending to server:



If device has made a record it is sent to the server every 120 seconds

After successful SMS configuration, FMC130 device will **synchronize time** and **update records** to **configured server**. Time intervals and default I/O elements can be changed by using [Teltonika Configurator](#) or [SMS parameters](#).

# Mounting recommendations

- Connecting wires
  - Wires should be connected while the module is not plugged in.
  - Wires should be fastened to stable wires or other non-moving parts. Any heat emitting and/or moving objects should be kept away from the wires.
  - There should be no exposed wires. If factory isolation was removed while connecting the wires, the isolation material should be applied.
  - If the wires are placed in the exterior or in places where they can be damaged or exposed to heat, humidity, dirt, etc., additional isolation should be applied and the wires should not be loose.
  - Wires cannot be connected to the board computers or control units.
- Connecting power source
  - Be sure that after the car computer goes to sleep mode, power might be still available on the power wires. Depending on the car model, this may happen in 5 to 30 minutes period.
  - When the module is connected, measure the voltage again to make sure it did not decrease.
  - It is recommended to connect to the main power cable in the fuse box.
  - 3 A, 125 V external fuse shall be used.
- Connecting ignition wire
  - Be sure to check if it is a real ignition wire i. e. power does not disappear after starting the engine.
  - Check if this is not an ACC wire (when key is in the first position, most of the vehicle electronics are available).
  - Check if power is still available when you turn off any of vehicles devices.
  - Ignition is connected to the ignition relay output. As alternative, any other relay, which has power output when ignition is on, may be chosen.
- Connecting ground wire
  - Ground wire is connected to the vehicle frame or metal parts that are fixed to the frame.
  - If the wire is fixed with the bolt, the loop must be connected to the end of the wire.
  - For better contact scrub paint from the spot where loop is going to be connected.

# LED indications

**Table 3 Navigation LED indications**

| BEHAVIOUR                | MEANING   |
|--------------------------|---|
| Permanently switched on  | GNSS signal is not received   |
| Blinking every second    | Normal mode, GNSS is working  |
| Off                      | GNSS is turned off because:<br>Device is not working or Device is in sleep mode |
| Blinking fast constantly | Device firmware is being flashed  |

**Table 4 Status LED indications**

| BEHAVIOUR                      | MEANING   |
|--------------------------------|---|
| Blinking every second          | Normal mode                                     |
| Blinking every two seconds     | Sleep mode                                      |
| Blinking fast for a short time | Modem activity                                  |
| Off                            | Device is not working or Device is in boot mode |

# Characteristics

# Basic characteristics

**Table 5 Basic characteristics**

| MODULE               |  |
|----------------------|--|
| Name                 | Quectel EC21-AU, Quectel EC21-EC, Teltonika TM2500   |
| Technology           | LTE(CaT1)/3G(UMTS/HSPA)/2G(GSM/GPRS)/GNSS/BLUETOOTH  |
| GNSS                 |  |
| GNSS                 | GPS, GLONASS, GALILEO, BEIDOU, QZSS, AGPS  |
| Receiver             | Tracking: 33   |
| Tracking sensitivity | -165 dBm   |
| Accuracy             | < 3 m  |
| Hot start            | < 1 s  |
| Warm start           | < 25 s   |
| Cold start           | < 35 s   |
| CELLULAR             |  |
| Technology           | LTE Cat 1, UMTS, GSM   |
| 2G bands             | EC21-AU: GSM: B2/B3/B5/B8<br>EC21-EC: GSM: B3/B8   |
| 3G bands             | EC21-AU: WCDMA: B1/B2/B5/B8<br>EC21-EC: WCDMA: B1/B8   |
| 4G bands             | EC21-AU: LTE FDD: B1/B2/B3/B4/B5/B7/B8/B28<br>LTE TDD: B40<br>EC21-EC: LTE FDD: B1/B3/B7/B8/B20/B28A   |
| Data transfer        | LTE: LTE FDD: Max 10Mbps (DL)/Max 5Mbps (UL)<br>LTE TDD: Max 8.96Mbps (DL)/Max 3.1Mbps (UL)<br>UMTS: WCDMA: Max 384Kbps(DL)/Max 384Kbps(UL)<br>GSM: GPRS: Max 107Kbps (DL)/Max 85.6Kbps (UL) |
| Data support         | SMS (text/data)  |
| POWER                |  |
| Input voltage range  | 10-30 V DC with overvoltage protection   |
| Back-up battery      | 170 mAh Li-Ion battery 3.7 V (0.63 Wh)   |
| Power consumption    | At 12V < 2.5 mA ( <a href="#">Ultra Deep Sleep</a> )<br>At 12V < 5 mA ( <a href="#">Deep Sleep</a> )<br>At 12V < 5.5 mA ( <a href="#">Online Deep Sleep</a> )                                |

At 12V < 18,5 mA ([GPS Sleep](#))  
 At 12V < 34 mA (nominal)

## BLUETOOTH

|                       |   |
|-----------------------|---|
| Specification         | 4.0 + LE  |
| Supported peripherals | <a href="#">Temperature and Humidity sensor</a> , <a href="#">OBDII dongle</a> , Inateck Barcode Scanner, Universal BLE sensors support |

## PHYSICAL SPECIFICATION

|            |                               |
|------------|-------------------------------|
| Dimensions | 65 x 56 x 20,6 mm (L x W x H) |
| Weight     | 55 g                          |

## INTERFACE

|                    |                                      |
|--------------------|--------------------------------------|
| Digital Inputs     | 3                                    |
| Negative Inputs    | 1 (Digital Input 2)                  |
| Impulse Inputs     | 2 (Digital Input 1, Digital Input 2) |
| Digital Outputs    | 3                                    |
| Analog Inputs      | 2                                    |
| CAN Adapter inputs | 1                                    |
| 1-Wire             | 1                                    |
| GNSS antenna       | Internal High Gain                   |
| Cellular antenna   | Internal LTE High Gain               |
| USB                | 2.0 Micro-USB                        |
| LED indication     | 2 status LED lights                  |
| SIM                | Micro-SIM + eSIM                     |
| Memory             | 128MB internal flash memory          |

## OPERATING ENVIRONMENT

|   |                          |
|---|--------------------------|
| Operating temperature (without battery) | -40 °C to +85 °C         |
| Storage temperature (without battery)   | -40 °C to +85 °C         |
| Operating humidity                      | 5% to 95% non-condensing |
| Ingress Protection Rating               | IP41                     |
| Battery charge temperature              | 0 °C to +45 °C           |
| Battery discharge temperature           | -20 °C to +60 °C         |

|                             |   |
|-----------------------------|---|
| Battery storage temperature | -20 °C to +45 °C for 1 month<br>-20 °C to +35 °C for 6 months |
|-----------------------------|---|

## FEATURES

|                                   |  |
|-----------------------------------|--|
| Sensors                           | Accelerometer  |
| Scenarios                         | <a href="#">Green Driving</a> , <a href="#">Over Speeding detection</a> , <a href="#">GNSS Fuel Counter</a> , <a href="#">DOUT Control Via Call</a> , <a href="#">Excessive Idling detection</a> , <a href="#">Immobilizer</a> , <a href="#">iButton Read Notification</a> , <a href="#">Unplug detection</a> , <a href="#">Towing detection</a> , <a href="#">Crash detection</a> , <a href="#">Auto Geofence</a> , <a href="#">Manual Geofence</a> , <a href="#">Trip</a> , <a href="#">Ground Sense</a> |
| Sleep modes                       | <a href="#">GPS Sleep</a> , <a href="#">Online Deep Sleep</a> , <a href="#">Deep Sleep</a> , <a href="#">Ultra Deep Sleep</a>  |
| Configuration and firmware update | <a href="#">FOTA Web</a> , <a href="#">FOTA</a> , <a href="#">Teltonika Configurator</a> (USB, Bluetooth), <a href="#">FMBT mobile application</a> (Configuration)   |
| SMS                               | Configuration, Events, DOUT control, Debug   |
| GPRS commands                     | Configuration, DOUT control, Debug   |
| Time Synchronization              | GPS, NITZ, NTP   |
| Fuel monitoring                   | LLS (Analog), <a href="#">LV-CAN200</a> , <a href="#">ALL-CAN300</a> , <a href="#">OBDII dongle</a> , <a href="#">CAN-CONTROL</a> , OBDII dongle   |
| Ignition detection                | Digital Input 1, Accelerometer, External Power Voltage, Engine RPM (CAN Adapters, OBDII dongle)  |

# Electrical characteristics

**Table 6 Electrical characteristics**

| CHARACTERISTIC DESCRIPTION                        | VALUE |      |      |      |
|---|-------|------|------|------|
|   | MIN.  | TYP. | MAX. | UNIT |
| <b>SUPPLY VOLTAGE</b>                             |       |      |      |      |
| Supply Voltage (Recommended Operating Conditions) | +10   |      | +30  | V    |

### DIGITAL OUTPUT (OPEN DRAIN GRADE)

|   |     |     |     |    |
|---|-----|-----|-----|----|
| Drain current (Digital Output OFF)                                  |     |     | 120 | μA |
| Drain current (Digital Output ON, Recommended Operating Conditions) | 0.1 | 0.5 |     | A  |
| Static Drain-Source resistance (Digital Output ON)                  | 400 | 600 |     | mΩ |

### DIGITAL INPUT

|  |       |     |                |    |
|--|-------|-----|----------------|----|
| Input resistance (DIN1)                          | 47    |     |                | kΩ |
| Input resistance (DIN2)                          | 38.45 |     |                | kΩ |
| Input resistance (DIN3)                          | 150   |     |                | kΩ |
| Input voltage (Recommended Operating Conditions) | 0     |     | Supply voltage | V  |
| Input Voltage threshold (DIN1)                   |       | 7.5 |                | V  |
| Input Voltage threshold (DIN2)                   |       | 2.5 |                | V  |
| Input Voltage threshold (DIN3)                   |       | 2.5 |                | V  |

### ANALOG INPUT

|   |   |       |     |    |
|---|---|-------|-----|----|
| Input voltage (Recommended Operating Conditions), Range 1 | 0 |       | +10 | V  |
| Input resistance, Range 1                                 |   | 38.45 |     | kΩ |
| Measurement error on 12V, Range 1                         |   | 0.9   |     | %  |
| Additional error on 12 V, Range 1                         |   | 108   |     | mV |
| Measurement error on 30 V, Range 1                        |   | 0.33  |     | %  |
| Additional error on 30 V, Range 1                         |   | 88    |     | mV |
| Input Voltage (Recommended Operating Conditions), Range 2 | 0 |       | +30 | V  |
| Input resistance, Range 2                                 |   | 150   |     | kΩ |
| Measurement error on 12 V, Range 2                        |   | 0.9   |     | %  |

|                                    |  |      |  |    |
|------------------------------------|--|------|--|----|
| Additional error on 12 V, Range 2  |  | 108  |  | mV |
| Measurement error on 30 V, Range 2 |  | 0.33 |  | %  |
| Additional error on 30 V, Range 2  |  | 88   |  | mV |

### OUTPUT SUPPLY VOLTAGE 1-WIRE

|   |      |    |      |    |
|---|------|----|------|----|
| Supply voltage                          | +4.5 |    | +4.7 | V  |
| Output inner resistance                 |      | 7  |      | Ω  |
| Output current ( $U_{out} > 3.0$ V)     |      | 30 |      | mA |
| Short circuit current ( $U_{out} = 0$ ) |      | 75 |      | mA |

### NEGATIVE INPUT

|  |       |     |                |    |
|--|-------|-----|----------------|----|
| Input resistance                                 | 38.45 |     |                | kΩ |
| Input voltage (Recommended Operating Conditions) | 0     |     | Supply voltage | V  |
| Input voltage threshold                          |       | 0.5 |                | V  |
| Sink current                                     |       |     | 180            | nA |

# Safety information

This message contains information on how to operate FMC130 safely. By following these requirements and recommendations, you will avoid dangerous situations. You must read these instructions carefully and follow them strictly before operating the device!

- The device uses SELV limited power source. The nominal voltage is +12 V DC. The allowed voltage range is +10..+30 V DC.
  - To avoid mechanical damage, it is advised to transport the device in an impact-proof package. Before usage, the device should be placed so that its LED indicators are visible. They show the status of device operation.
  - When connecting the 2x6 connector wires to the vehicle, the appropriate jumpers of the vehicle power supply should be disconnected.
  - Before unmounting the device from the vehicle, the 2x6 connector must be disconnected. The device is designed to be mounted in a zone of limited access, which is inaccessible to the operator. All related devices must meet the requirements of EN 60950-1 standard.
- The device FMC130 is not designed as a navigational device for boats.



**Do not disassemble the device. If the device is damaged, the power supply cables are not isolated or the isolation is damaged, DO NOT touch the device before unplugging the power supply.**



**All wireless data transferring devices produce interference that may affect other devices which are placed nearby.**



**The device must be connected only by qualified personnel.**



**The device must be firmly fastened in a predefined location.**



**The programming must be performed using a PC with autonomic power supply.**



**Installation and/or handling during a lightning storm is prohibited.**



**The device is susceptible to water and humidity.**



**Risk of explosion if battery is replaced by an incorrect type. Dispose of used batteries according to the instructions.**



**Battery should not be disposed of with general household waste. Bring damaged or worn-out batteries to your local recycling center or dispose them to battery recycle bin found in stores.**

# Certification and Approvals

- [FMC130 EAC](#)
- [FMC130 REACH](#)
- [FMC130 Declaration of IMEI assignment](#)
- [FMC130 CE / RED](#)
- [FMC130 E-Mark](#)
- [FMC130 RoHS](#)
- [FMC130 Declaration of device operation temperature](#)

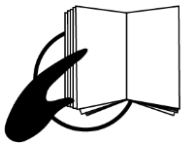

This sign on the package means that it is necessary to read the User's Manual before your start using the device. Full User's Manual version can be found in our [Wiki](#).



This sign on the package means that all used electronic and electric equipment should not be mixed with general household waste.



Hereby, Teltonika declare under our sole responsibility that the above described product is in conformity with the relevant Community harmonization: European Directive 2014/53/EU (RED).

# Warranty

TELTONIKA guarantees its products to be free of any manufacturing defects for a period of **24 months**. With additional agreement we can agree on a different warranty period, for more detailed information please contact our sales manager.

Contact us [teltonika.lt/company/contacts](https://teltonika.lt/company/contacts)

**All batteries carry a reduced 6 month warranty period.**

If a product should fail within this specific warranty time, the product can be:

- Repaired
- Replaced with a new product
- Replaced with an equivalent repaired product fulfilling the same functionality
- TELTONIKA can also repair products that are out of warranty at an agreed cost.

# Warranty Disclaimer

**TELTONIKA PRODUCTS ARE INTENDED TO BE USED BY PERSONS WITH TRAINING AND EXPERIENCE. ANY OTHER USE RENDERS THE LIMITED WARRANTIES EXPRESSED HEREIN AND ALL IMPLIED WARRANTIES NULL AND VOID AND SAME ARE HEREBY EXCLUDED. ALSO EXCLUDED FROM THIS LIMITED WARRANTY ARE ANY AND ALL INCIDENTAL OR CONSEQUENTIAL DAMAGES INCLUDING BUT NOT LIMITED TO, LOSS OF USE OR REVENUE, LOSS OF TIME, INCONVENIENCE OR ANY OTHER ECONOMIC LOSS.**

More information can be found at [teltonika.lt/warranty-repair](https://teltonika.lt/warranty-repair)